

Technical Manual

for

**Model No. AVC1 (XB101-2)
Advanced Voltage Controller, 28V**

With Over-Voltage Protection, Charging-System Fault & Low-Voltage Sensing,
And Field-Adjustable Charging Voltage

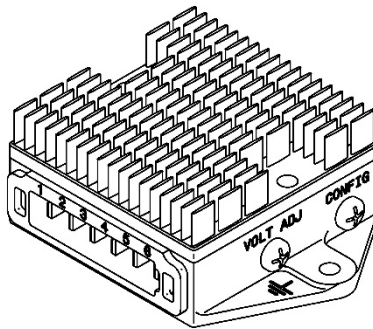

Including:

Installation Instructions;
Troubleshooting Guide; and
Instructions for Continued Airworthiness

**B & C Specialty Products
P.O. Box B
Newton, KS 67114
(316) 283-8000**

bandc.com

XB101-2-TM (5/15/2023)

NOTE

The AVC1 Advanced Voltage Controller is not STC'd or PMA'd and is intended for installation on amateur-built aircraft only.



INTRODUCTION

The AVC1 / XB101-2 is an external, 28V shunt-type voltage regulator/rectifier designed for use with single-phase permanent-magnet alternators up to 20A in size. Over-voltage (OV) protection, Charging System-Fault (CSF) and Low-Voltage (LV) warning output, and field-adjustable charging voltage are integrated into the AVC1 / XB101-2 control package.

KNOWN INCOMPATIBILITIES

Application	Issue(s)
Revmaster Engine	Alternator stator winding overheats when pushed too hard (incompatible with a shunt-type regulator).
Jabiru Engine	Alternator stator winding overheats when pushed too hard (incompatible with a shunt-type regulator).
TL Sport Aircraft	Typical installation requires the alternator AC output to drive the hour-meter (does not work with an AVC1/ XB101-2).

OVERVIEW

The terminal layout of the AVC1 / XB101-2 follows the configuration established by the Rotax OEM (Ducati) regulator.

Ducati terminal layout (typ.)

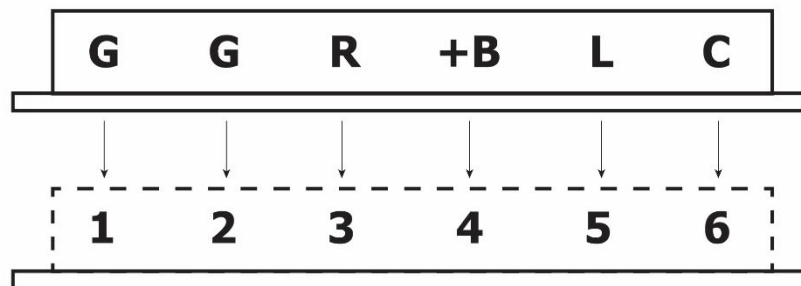

Re-use of the OEM-style connector plug is possible with the AVC1 / XB101-2, if desired -- a matching receptacle has been integrated into the unit enclosure to facilitate convenient transition from one regulator to the other. **Note:** if the connector plug is retained, replacement of the individual wire terminals secured inside is highly recommended using installation kit FK514-1 (see pg. A-3).

AVC1 / XB101-2 terminal functions are as follows –

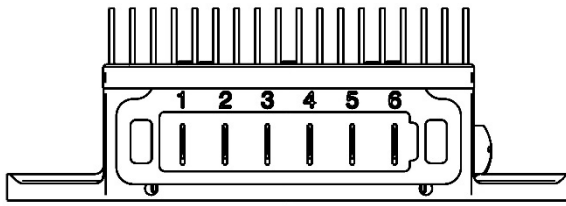

- 1 & 2 - AC Input
- 3 & 4 - DC Output (+)
- 5 - CSF/LV Warning Output
- 6 - Control Input
- Case - Ground

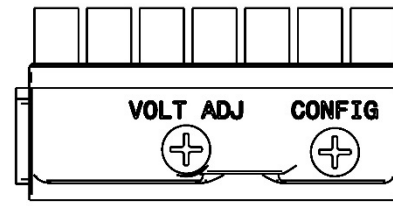

- VOLT ADJ - Voltage Regulation Adjustment
- CONFIG - Low-Voltage Warning Output Configuration

Terminals 1 & 2 - These are common AC inputs from the permanent magnet alternator/dynamo. This AC current passes through an 30A relay within the AVC1 that is controlled by the Terminal 6 input as well as the internal Over-Voltage protection circuit. There is no polarity in these AC input terminals.

Terminals 3 & 4 - These are common, positive DC outputs from the AVC1 which will provide power to the aircraft electrical system. The wire from these terminals should be capable of carrying the full alternator output and protected with an appropriately sized circuit protective device (see Section F, “System Schematics”).

NOTE

For 20A alternators, it is strongly recommended that Terminals 3 & 4 be connected in parallel in order to split the current between the wire terminals used in the aircraft harness. On the AVC1 side, one terminal can carry all 20A; however, the ability of the mating terminal to carry 20A is dependent on various other factors, such as the terminal material, tightness of fit, and the integrity of the crimp joint itself.

Voltage sense for regulation and OV protection is also at these terminals. The current drain into these terminals when the alternator is not operating is just under 1mA, allowing them to be always connected to the aircraft bus without significantly impacting run time of battery-only operations.

Terminal 5 - This output supplies the Charging-System Fault (CSF) and Low-Voltage (LV) warning output. CSF warning – indicated with a *steady* light – will be present when the AVC1 detects no output from the alternator. LV warning – indicated with a *flashing* light – will be present when bus voltage falls below the user-selected voltage threshold. Note: when active, this output pulls to ground; when not active, it is pulled up with a diode-isolated internal pullup to approximately 1.5V less than the bus. It will support up to 100mA continuous load and is intended to ground an annunciator light (either incandescent or LED), or be used as an output to feed an aircraft EFIS or other similar display.

Terminal 6 - This is the Control input and is typically connected to an alternator switch that provides aircraft bus voltage. When power is provided to this terminal, alternator output will be enabled. Current into this terminal during normal operation is 100mA. This terminal may also be wired to Terminal 3 and 4 and all of them switched by the alternator switch; however, this would require a heavy-duty switch capable of carrying full alternator output.

Case Ground - The AVC1 enclosure provides connection to the aircraft grounding system. This connection should be capable of carrying full alternator output. Case ground is also the reference used by the AVC1 for voltage regulation.

VOLT ADJ - This 12-turn potentiometer, covered by a machine screw cap, permits plus/minus user adjustment of the AVC1 output voltage set-point (see below, “System Function”).

CONFIG – This pair of DIP switches, covered by a machine screw cap, permits user selection from among several available options for Low-Voltage (LV) Warning output (see Section B, “Configuration”).

SYSTEM FUNCTION

The AVC1 is pre-set to control alternator output voltage at 28.8V. If voltage adjustment is desired, this may be accomplished by accessing the 12-turn potentiometer located behind the machine screw cap labeled “VOLT ADJUST” on the side of the AVC1 enclosure. Each full turn of the potentiometer will adjust the voltage by approximately 0.2 volts (clockwise to increase, counterclockwise to decrease). The available range of adjustment is approximately 27.2V-29.6V. Use a handheld digital voltmeter at the battery to confirm any field adjustment.

NOTE

The pre-set charging voltage of the AVC1 should be suitable for most 24V Sealed Lead Acid (SLA) and Valve-Regulated Sealed Lead Acid (VRSLA) batteries. Electrical systems using legacy “Flooded” batteries, or Lithium (LiFePO or similar) batteries, may require field adjustment. Consult the documentation provided by your battery manufacturer to ensure adequate performance and battery service life.

In normal operation the Charging-System Fault (CSF) warning light will not be illuminated. The Low-Voltage (LV) warning light may flash in response to low engine RPM and high bus load; or it may flash to indicate an emerging problem in the charging system.

The AVC1 is equipped with dynamic Over-Voltage (OV) protection that will actively intervene in response to abnormal bus voltage. This protective response is governed by a 3-tier range of system voltages and durations, with these values established by the version of control software (SW) installed:

OV Tier	SW 3.0
OV1	30.4V / 5 sec
OV2	32.0V / 500 ms
OV3	40.0V / 50 ms

In the event the OV protection feature is triggered, the AVC1 will disconnect the alternator from the aircraft bus and activate the CSF warning output. The alternator will remain off-line until power is cycled at the Terminal 6 control input by turning OFF the alternator switch (or by manually opening and closing the Control circuit breaker, if the aircraft is so equipped).

The AVC1 is also equipped with a user-selectable Low-Voltage (LV) warning capability (see Section B, “Configuration”). If the CSF and LV warning are both active at the same time, the LV warning will take priority.

PARTS LISTS

The following parts are supplied when the AVC1 is ordered with the FK514-1 Installation Kit:

<u>Qty.</u>	<u>Part No.</u>	<u>Description</u>
1	XB101-2	AVC1 Advanced Voltage Controller
2	S8038-1	Wire Terminal, Phosphor-Bronze, 12AWG
2	S8038-2	Wire Terminal, Phosphor-Bronze, 14 AWG
2	S8038-3	Wire Terminal, Phosphor-Bronze, 20AWG

The following parts are supplied when the AVC1 is ordered with the FK514-2 Installation Kit:

<u>Qty.</u>	<u>Part No.</u>	<u>Description</u>
1	XB101-2	AVC1 Advanced Voltage Controller
2	S8038-2	Wire Terminal, Phosphor-Bronze, 14AWG
2	S816Y248	Heatshrink, Yellow
1	514-200-1	Wire Assembly, Red, DC Output
1	514-200-2	Wire Assembly, Black, Capacitor Ground
1	514-200-3	Wire Assembly, White, Warning Output
1	514-200-4	Wire Assembly, Blue, Control Circuit

The following parts are supplied when the AVC1 is ordered with the FK514-3 Installation Kit:

<u>Qty.</u>	<u>Part No.</u>	<u>Description</u>
1	XB101-2	AVC1 Advanced Voltage Controller
2	S8038-2	Wire Terminal, Phosphor-Bronze, 14AWG
1	514-201-5	Wire Harness (w/ Pre-Wired Mating Plug), AVC1

The following parts are supplied when the AVC1 is ordered with the FK514-4 Installation Kit:

<u>Qty.</u>	<u>Part No.</u>	<u>Description</u>
1	XB101-2	AVC1 Advanced Voltage Controller
2	42844-2	Wire Terminal, PIDG, Phosphor-Bronze, 12AWG
4	9-160313-6	Wire Terminal, PIDG, Phosphor-Bronze, 14 AWG
2	9-160583-5	Wire Terminal, PIDG, Phosphor-Bronze, 20AWG

The following individual parts are available to support an AVC1 installation:

<u>Part No.</u>	<u>Description</u>
CB10 or CB15	Circuit Breaker, Alternator Output
S8040-xxx	MIDI Bolt-down Fuse, Alternator Output
S8041-1	Base, Bolt-down Fuse
S8041-2	Input Module, Bolt-down Fuse
S8042-x	Busbar Segment, Bolt-down Fuse Base
CB2 (typical)	Circuit Breaker, Warning Output
CB5 (typical)	Circuit Breaker, Control
S700-2-10	Switch, Toggle, DPDT, Progressive Transfer
S8007-1	Electrolytic Filter Capacitor, 10000 uF @ 50 VDC
S8007-3	Electrolytic Filter Capacitor, 22000 uF @ 40 VDC
M22759/16-22-9	Wire, 22 AWG, White, Tefzel
M22759/16-12-9	Wire, 12 AWG, White, Tefzel

Field Kits and individual parts listed above are available directly from B&C Specialty Products, bandc.com, phone: 316-283-8000.

CHANGE IN WEIGHT AND BALANCE

The AVC1 Advanced Voltage Controller weighs a nominal 0.5 lbs. Variations in airframe station references for all aircraft affected by this kit preclude including pre-calculated weight and balance data in this manual. Weight of electrical accessories and hardware will vary for each individual installation. The installer is responsible for ensuring that aircraft weight and balance are correct.

CONFIGURATION

The AVC1 is designed to provide warning output for both Charging-System Fault (CSF) and Low-Voltage (LV) conditions. LV warning is user-selected to trigger at one of three voltage thresholds. It may also be disabled, if desired or if alternate means of Low-Voltage annunciation is available through another device or display.

Configuration of the available LV annunciation options is set by the position of two small DIP switches, accessed by removing the machine screw cap labeled “CONFIG” on the side of the AVC1 enclosure (see Figure A, below). The position of the DIP switches is read by the AVC1 each time power is applied to the unit.

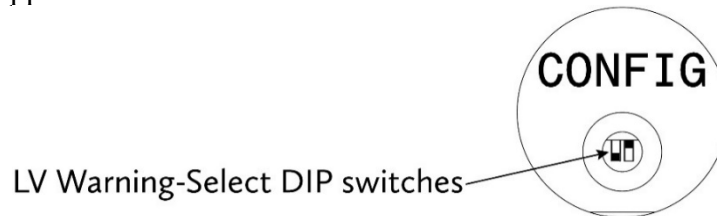

Figure A

To select the AVC1 LV warning output threshold appropriate for your installation and battery type, position the two DIP switches according to the table below:

LV Warning Output	Switch 1	Switch 2
Disable	DOWN	DOWN
25.4V (factory preset)	DOWN	UP
26.0V	UP	DOWN
27.0V	UP	UP

Note: DIP switch 1 is on the left-hand side, and DIP switch 2 is on the right.

The intent of the above options is to make possible a range of alternatives for installations using an EFIS display vs. discrete warning annunciator; and for installations requiring appropriate LV warning for Lithium-ion vs. lead-acid batteries. For example –

- **DISABLE** – Use this setting if you have an EFIS which will provide its own LV warning.
- **25.4V** – Use this setting if you have a lead-acid battery and a discrete annunciator.
- **26.0V** – Use this setting if you have a Lithium battery and a discrete annunciator, and require delayed warning.
- **27.0V** – Use this setting if you have a Lithium battery and a discrete annunciator, and require immediate warning.

Individual user preference may influence these choices as well. Consult the Manufacturer’s specifications for your EFIS display and/or battery to select the warning output settings best suited to your installation.

INSTALLATION

Preparation

- Step 1. Refer to applicable service manual instructions; remove and retain engine cowl. Disconnect ship's battery, Negative (-) terminal first.
- Step 2. Refer to applicable service manual instruction; remove existing regulator.
- Step 3. Select a suitable location to mount the AVC1 and the filter capacitor (if applicable). Mounting the AVC1 on the forward side of the firewall, terminal strip DOWN, in an area where air movement will be present, is preferred. Take care to choose a mounting

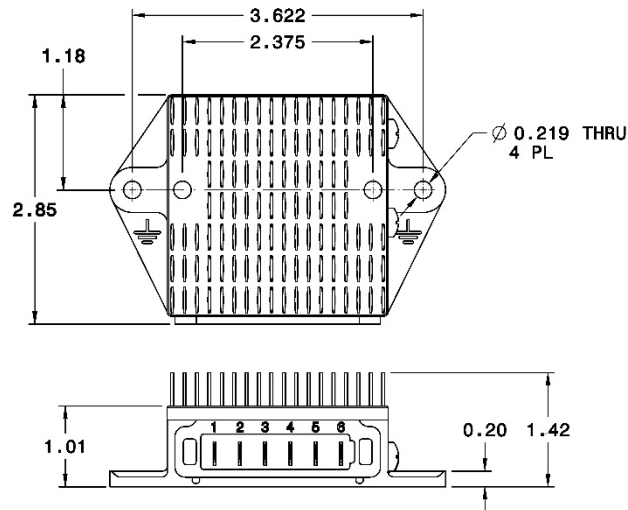

location that will protect the AVC1 from excessive heat, vibration, and water. If possible, select a common location to Ground both the AVC1 and battery. Note: the filter capacitor may be mounted immediately adjacent to the AVC1 for ease of wiring.

NOTE

The AVC1 is designed to operate without a filter capacitor; however, a capacitor may be useful for noise suppression purposes, or to meet other installation requirements of your Alternator/dynamo. Consult the Manufacturer's specifications for your Alternator/dynamo to determine whether a filter capacitor is required for your installation.

- Step 4. Select a suitable location to mount the warning light (recommended, user supplied) for Charging-System Fault (CSF) and Low-Voltage (LV) indication in the instrument panel. The light should be within the pilot's peripheral vision; generally, a 45-degree angle in front of the pilot. A panel location away from direct sunlight is preferred.

- Step 5. Select a suitable panel location to mount the control circuit breaker, annunciation circuit breaker, and alternator output circuit breaker. A panel location within the pilot's field of vision and reach is recommended for these circuit breakers. If a current limiter will be used to protect the alternator output circuit, an accessible location on the forward side of the firewall near the battery is recommended for that device.
- Step 6. Select a suitable panel location to mount the battery/alternator master switch.

Controller Installation (with FK514-2 kit)

Note: reference the appropriate wiring diagram for your installation in Section F ("System Schematics") for Steps 7-13 below.

- Step 7. Mount the AVC1 and filter capacitor (if applicable) to the firewall or selected location. The capacitor may be mounted using an appropriately-sized MS21919-WDG adel clamp (or similar) and secured in place on the left-hand mounting flange of the AVC1 (preferred) so as to preserve access to the voltage adjustment. On a metal firewall, AN3 bolts, AN960 flat washers, and AN365 locking nuts will be adequate to secure the AVC1 and capacitor in place.
- Step 8. Install the supplied S8038-2 phosphor-bronze wire terminals on the two AC leads coming from the alternator/dynamo. Install the supplied S816Y248 yellow heatshrink over each of the crimped terminals, ensuring that the terminal ends remain open but that the pre-insulated and exposed portions of the terminals are otherwise covered. Connect the finished AC leads to terminals 1 and 2 of the AVC1.

NOTE

There is NO polarity in the AC leads between the AVC1 and the alternator/dynamo. The connections to Terminals 1 and 2 of the AVC1 may be arranged as convenient for your installation.

- Step 9. Wire the AVC1 DC power output circuit using the supplied 514-200-1 (red) wire assembly. Connect the pre-finished leads to terminals 3 & 4 of the AVC1, and the pre-installed ring terminal to the positive (+) post of the filter capacitor. Slide the insulated terminal boot (pre-positioned on the assembly) to cover the positive (+) post connection. Route the unfinished end of the 514-200-1 assembly to the bus and install an appropriate wire terminal for connection to the output circuit breaker or current limiter(s).
- Step 10. Wire the Ground wire for the filter capacitor using the supplied 514-200-2 (black) wire assembly. Connect the pre-installed ring terminal to the negative (-) post of the filter capacitor (if applicable). Route the unfinished end of the 514-200-2 wire assembly to either Ground location on the AVC1 enclosure (indicated with the \perp symbol), aircraft Grounding block, or airframe Ground.

- Step 11. Wire the AVC warning output circuit using the supplied 514-200-3 (white) wire assembly. Connect the pre-finished lead to terminal 5 of the AVC1. Route the unfinished end of the 514-200-3 assembly to the alternator warning annunciator light (incandescent or LED), or appropriate EFIS display input. Trim the harness to length, install an appropriate wire terminal for connection to the warning light or EFIS. If a warning light is used, wire to warning output circuit breaker or fuse to complete the connection; if an EFIS display is used, a circuit breaker or fuse is not required.
- Step 12. Wire the AVC1 control circuit using the supplied 514-200-4 (blue) wire assembly. Connect the pre-finished lead to terminal 6 of the AVC1. Route the unfinished end of the 514-200-4 assembly to the battery/alternator master switch. Trim the harness to length, install appropriate wire terminals for the switch and control circuit breaker, and complete the connections.
- Step 13. Fabricate a power Ground wire for the AVC1, using 12AWG M22759/16 Tefzel wire and appropriately sized ring terminals for the Ground location. Connect the AVC1 to Ground. Typically, this can be accomplished by connecting one of the two mounting flanges on the AVC1 enclosure to the aircraft firewall Ground, Grounding Block pass-thru bolt, or Negative (-) post on the battery.

NOTE

This step is important for all airframes, and *crucial* for composite aircraft. The AVC1 obtains connection to aircraft Ground through either mounting ear of the enclosure (identified with the \perp symbol).

- Step 14. Connect ship's battery, Negative (-) terminal last, and replace engine cowl.
- Step 15. Test the installation as follows —
- A. Low-voltage indication: turn the battery/alternator master switch ON, and observe the warning light or EFIS display. Depending on the selected Low-Voltage warning threshold (see Section B, "Configuration") and condition of the battery, this light may or may not flash immediately. If it does not begin flashing, turn on the landing light or the nav lights to lower the battery voltage sufficiently to trigger the LV output.
 - B. System charging: start the engine according to normal procedure. With the engine running and the battery/alternator switch ON, an increase in bus voltage between 27.6 and 28.8 volts should be observed (typically), depending on the electrical load, engine RPM, and type of alternator. Refer to the supporting documents for the alternator/dynamo to determine the RPM at which measurable output may be expected. The Low-Voltage warning light should no longer be flashing.
- Step 16. Update ship's weight and balance, pilot operating handbook and maintenance records.

OPERATION OF THE AVC1

Start-Up

Turn ON battery/alternator master switch(s). Perform a normal engine start. Proceed with other pre-flight procedures. Note: there is no significant difference between turning the alternator ON before or after engine start.

In-Flight

Bus voltage in flight will normally be maintained at 28.8V (+/- 0.4V), unless the AVC1 output set-point has been re-adjusted in the field. Bus voltage below this set-point can also be present if bus load exceeds alternator capacity, or if there has been a failure at some point in the charging system.

Low-Voltage (LV) warning indication will become active when voltage drops below the user-selected LV threshold. Indication may be in the form of a *flashing* incandescent/LED warning light or an alarm on your EFIS (or other similar display), depending on your installation. This warning indication will persist until the LV condition ceases.

Charging-System Fault (CSF) warning indication will become active when the AVC1 detects no output from the alternator. This includes when an Over-Voltage (OV) condition has been detected and the AVC1 shuts down the charging system. Indication may be in the form of a *steady* incandescent/LED warning light or an alarm on your EFIS (or other similar display), depending on your installation.

NOTE

If separate battery and alternator master switches are installed, the battery switch should not be switched OFF whenever the Alternator master is ON and the engine is running. The filtering capability of a healthy battery will help the AVC1 maintain a stable bus voltage and satisfy the power-quality requirements of certain electronic devices.

If CSF warning is indicated, cycling the alternator portion of the battery/alternator master switch may be performed to attempt a reset of the system. Alternately, the control circuit breaker may be manually opened and closed to attempt a reset. If the CSF warning persists, the reset was unsuccessful, and the charging system will remain off-line until the root condition is corrected.

Shutdown

Perform a normal engine shutdown. Turn OFF battery/alternator master switch.

TROUBLESHOOTING

CONDITION	POSSIBLE CAUSE	SUGGESTED ACTION
Charging system off-line (no output)	Engine at idle or low RPM	Reduce load until increased engine RPM possible.
	Output circuit breaker/current limiter open	Check breaker/limiter condition. Investigate whether open condition indicative of short-circuit or other “hard fault” in circuit.
	Output circuit breaker/current limiter failed	Test for voltage drop in breaker/limiter. Consider replacement if voltage drop greater than 0.25 volts detected. If equipped with current limiter, evaluate and replace if open.
	DC output wire broken, or has failed crimp joint	Replace broken wire assembly; or remove old crimp joint, dress and crimp new wire terminal on output wire.
	Control circuit breaker open	Check breaker condition. Investigate whether open condition a result of chaffed or abraded wire insulation at wire bundle ties or firewall pass-thru.
	Control breaker failed	Test for voltage drop in circuit breaker. Consider replacement if voltage drop greater than 0.25 volts detected.
	Control wire broken, or has failed crimp joint(s)	Replace broken wire assembly; or remove old crimp joint, dress and crimp new wire terminal on control wire.
Alternator not supporting load (insufficient output)	Electrical system load exceeds alternator capacity	Evaluate “continuous” power requirements and reconfigure load management practice.
	Alternator/stator damaged or failing	Repair or replace alternator/stator.
Alternator over-voltage condition indicated	Inadequate aircraft Ground reference, or loss of connection to aircraft Ground	Confirm resistance between the battery negative (-) terminal and either Ground connection point on regulator ($\frac{1}{2}$) is less than 0.50 ohms. Use a digital multi-meter on the lowest scale for this measurement. Resistance in excess of this value warrants further investigation.
	Regulator failure	Repair or replace regulator.
Excessive alternator “noise” audible in headsets	Inadequate or degraded Ground connections for alternator, regulator, and/or audio or radio systems	Check for corrosion or lack of cleanliness at Grounding points. Ensure that gas-tight connections are present at each connection in Ground system.

SYSTEM SCHEMATICS

Figure 1: PM Alternator w/ firewall-forward power feed and battery contactor

NOTES:

- (1) STANDARD B&C CAPACITOR IS 10,000 μ F. 22,000 μ F CAPACITOR IS AVAILABLE; RETROFIT INSTALLATIONS MAY USE EXISTING CAPACITOR.
- (2) ALTERNATOR WIRES HAVE NO POLARITY AND MAY BE HOOKED UP ON EITHER TERMINAL. COLORS SHOWN APPLY TO HEAT SHRINK TUBING USED ON B&C HARNESS.
- (3) IF POSSIBLE, USE A COMMON LOCATION TO GROUND BOTH REGULATOR AND BATTERY.

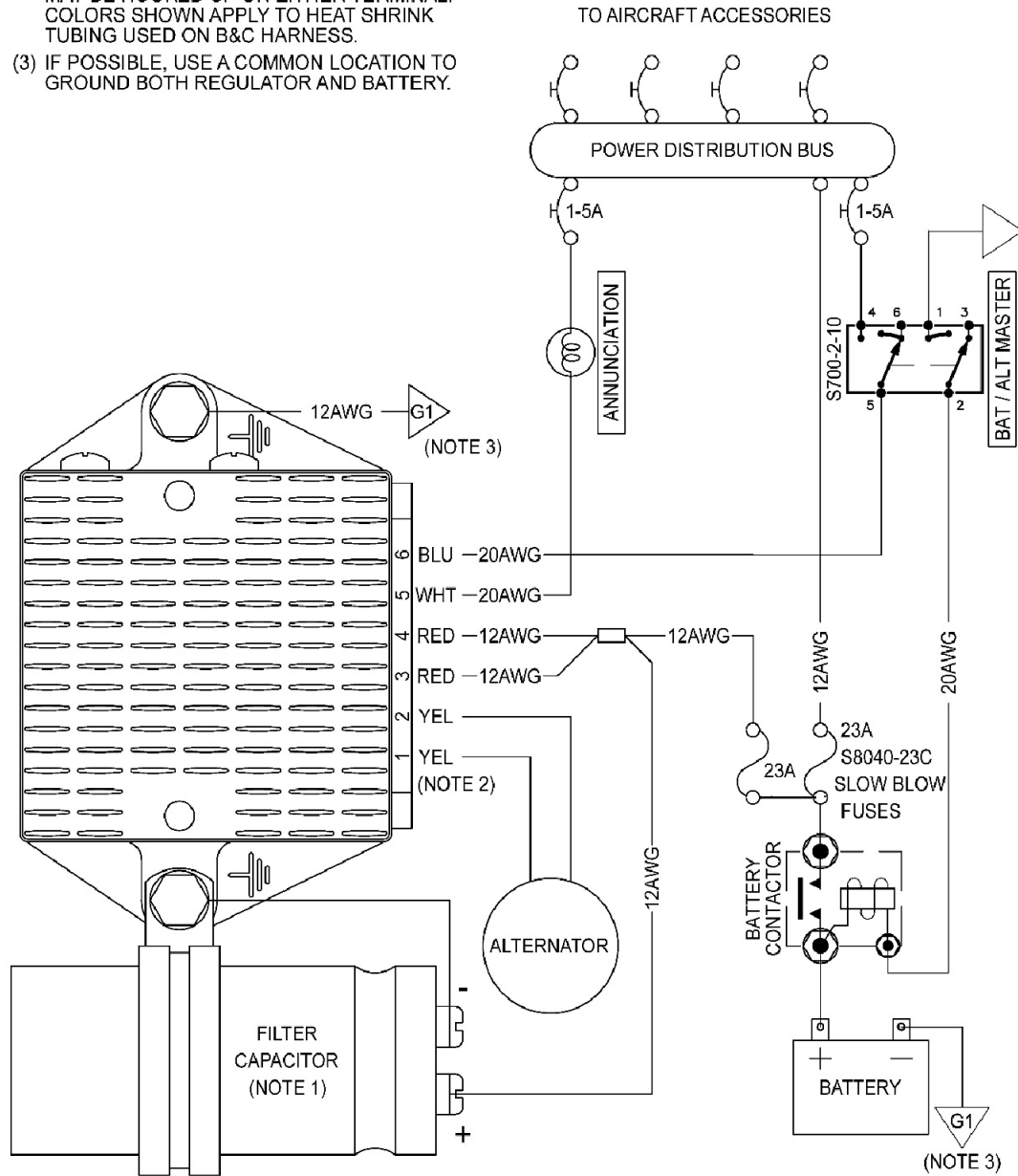

SYSTEM SCHEMATICS

Figure 2: PM Alternator w/ panel-mount power feed and battery contactor

NOTES:

- (1) STANDARD B&C CAPACITOR IS 10,000uF. 22,000uF CAPACITOR IS AVAILABLE; RETROFIT INSTALLATIONS MAY USE EXISTING CAPACITOR.
- (2) ALTERNATOR WIRES HAVE NO POLARITY AND MAY BE HOOKED UP ON EITHER TERMINAL. COLORS SHOWN APPLY TO HEAT SHRINK TUBING USED ON B&C HARNESS.
- (3) IF POSSIBLE, USE A COMMON LOCATION TO GROUND BOTH REGULATOR AND BATTERY.
- (4) SIZE CIRCUIT PROTECTION & WIRE PER TABLE BELOW. FEEDER FUSE MUST BE A SLOW BLOW TYPE FUSE. DO NOT SUBSTITUTE A FAST ACTING FUSE.

ALTERNATOR SIZE	CB	MIDI FUSE	WIRE SIZE
8A (SD8)	10A	S8040-23C	12 AWG
12A (200G)	15A	S8040-23C	12 AWG
15-18A	20A	S8040-30C	10 AWG
20A	25A	S8040-30C	10 AWG

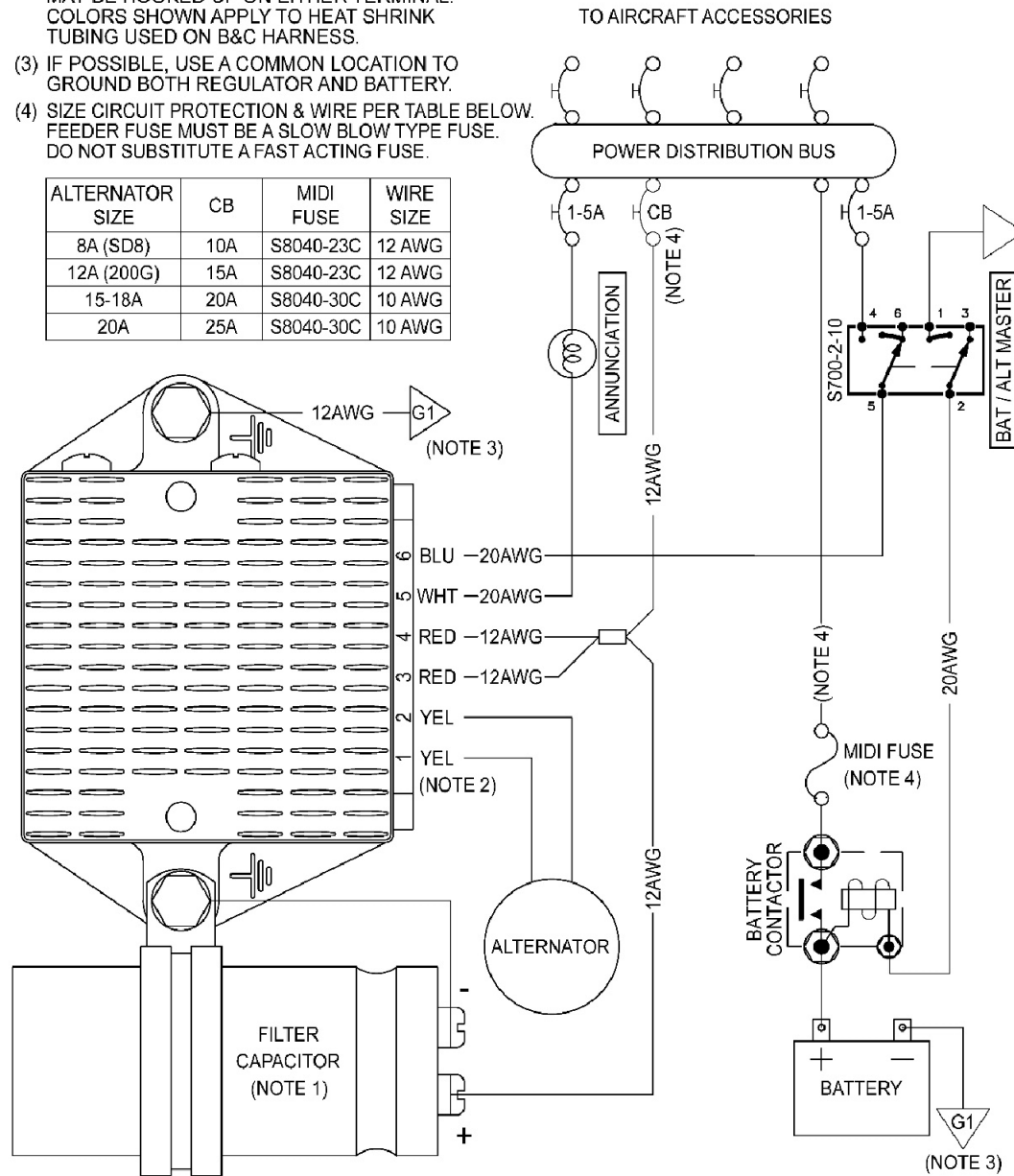

SYSTEM SCHEMATICS

Figure 3: PM Alternator w/ firewall-forward power feed

NOTES:

- (1) STANDARD B&C CAPACITOR IS 10,000 μ F. 22,000 μ F CAPACITOR IS AVAILABLE; RETROFIT INSTALLATIONS MAY USE EXISTING CAPACITOR.
- (2) ALTERNATOR WIRES HAVE NO POLARITY AND MAY BE HOOKED UP ON EITHER TERMINAL. COLORS SHOWN APPLY TO HEAT SHRINK TUBING USED ON B&C HARNESS.
- (3) IF POSSIBLE, USE A COMMON LOCATION TO GROUND BOTH REGULATOR AND BATTERY.
4. IN THIS CONFIGURATION, THE AVC1 VOLTAGE CONTROLLER WILL PLACE A 1mA PARASITIC LOAD ON THE BATTERY WHEN THE BATTERY MASTER SWITCH IS OFF. THIS WOULD DRAIN A 10AH BATTERY IN 13 MONTHS.
- (5) DIRECTLY SWITCHING THE BATTERY WITHOUT A CONTACTOR IS NOT RECOMMENDED WHEN EQUIPPED WITH ALTERNATOR LARGER THAN 12A.

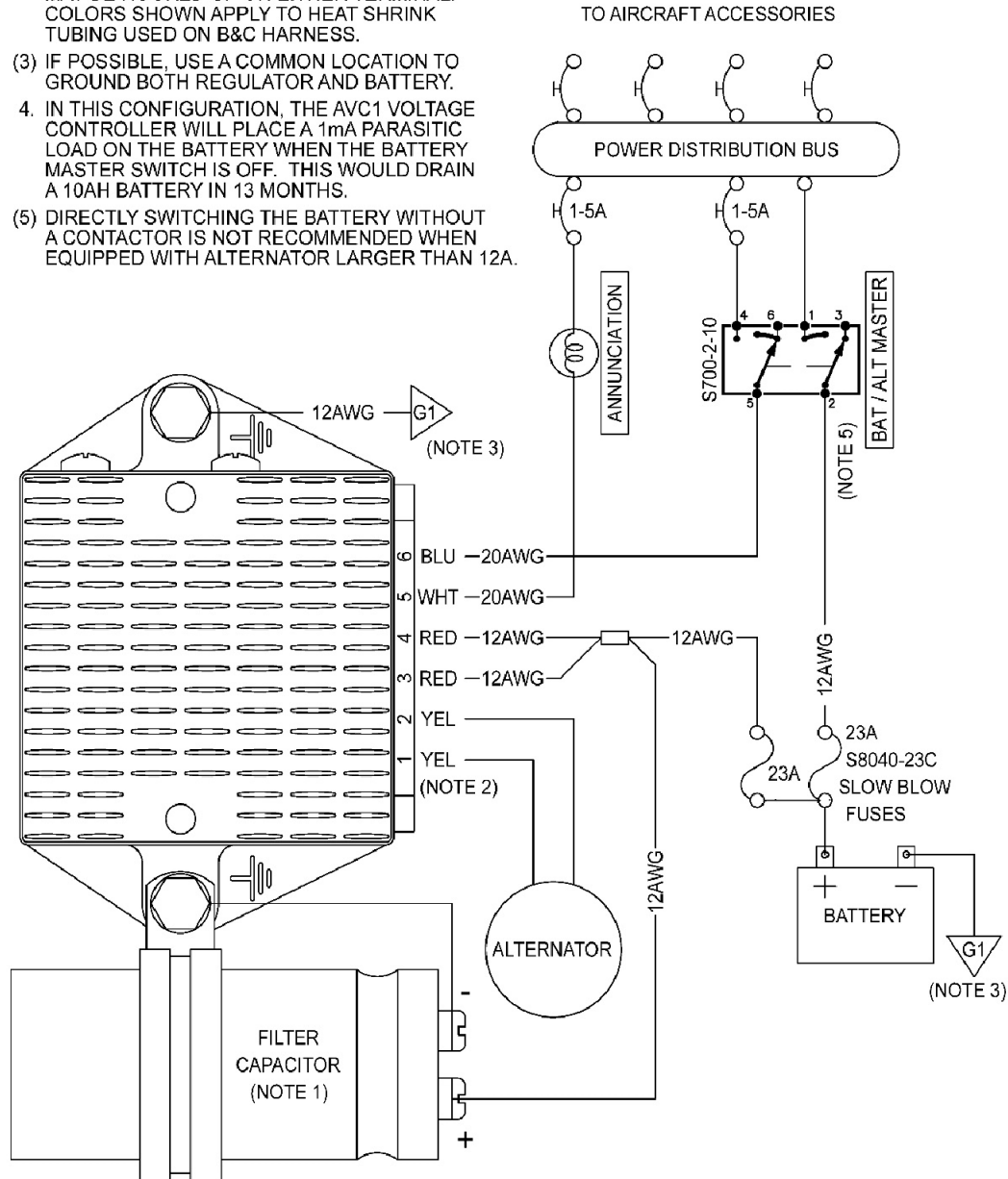

SYSTEM SCHEMATICS

Figure 4: PM Alternator w/ panel-mount power feed

NOTES:

(1) STANDARD B&C CAPACITOR IS 10,000 μ F. 22,000 μ F CAPACITOR IS AVAILABLE; RETROFIT INSTALLATIONS MAY USE EXISTING CAPACITOR.

(2) ALTERNATOR WIRES HAVE NO POLARITY AND MAY BE HOOKED UP ON EITHER TERMINAL. COLORS SHOWN APPLY TO HEAT SHRINK TUBING USED ON B&C HARNESS.

(3) IF POSSIBLE, USE A COMMON LOCATION TO GROUND BOTH REGULATOR AND BATTERY.

(4) SIZE CIRCUIT PROTECTION PER TABLE BELOW:

ALTERNATOR SIZE	CB
8A (SD8)	10A
12A (200G)	15A

(5) DIRECTLY SWITCHING THE BATTERY WITHOUT A CONTACTOR IS NOT RECOMMENDED WHEN EQUIPPED WITH ALTERNATOR LARGER THAN 12A.

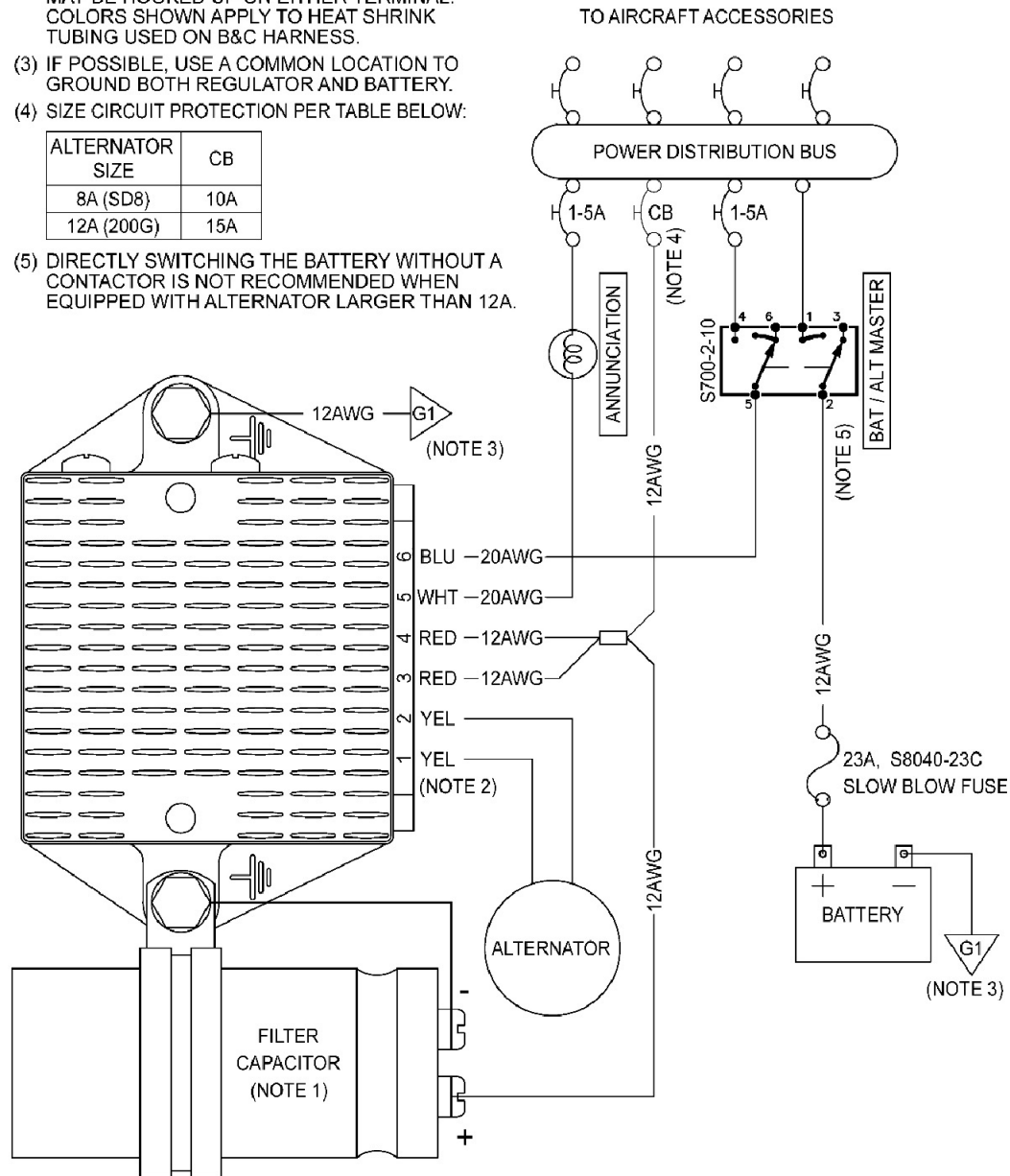

SYSTEM SCHEMATICS

Figure 5: Retrofit for Existing B&C PM Alternator Installation

NOTES:

(1) STANDARD B&C CAPACITOR IS 10,000uF. 22,000uF CAPACITOR IS AVAILABLE; RETROFIT INSTALLATIONS MAY USE EXISTING CAPACITOR.

(2) ALTERNATOR WIRES HAVE NO POLARITY AND MAY BE HOOKED UP ON EITHER TERMINAL. COLORS SHOWN APPLY TO HEAT SHRINK TUBING USED ON B&C HARNESS.

(3) SIZE CIRCUIT PROTECTION PER TABLE BELOW:

ALTERNATOR SIZE	CB
8A (SD8)	10A
12A (200G)	15A

(4) DIRECTLY SWITCHING THE BATTERY WITHOUT A CONTACTOR IS NOT RECOMMENDED WHEN EQUIPPED WITH ALTERNATOR LARGER THAN 12A.

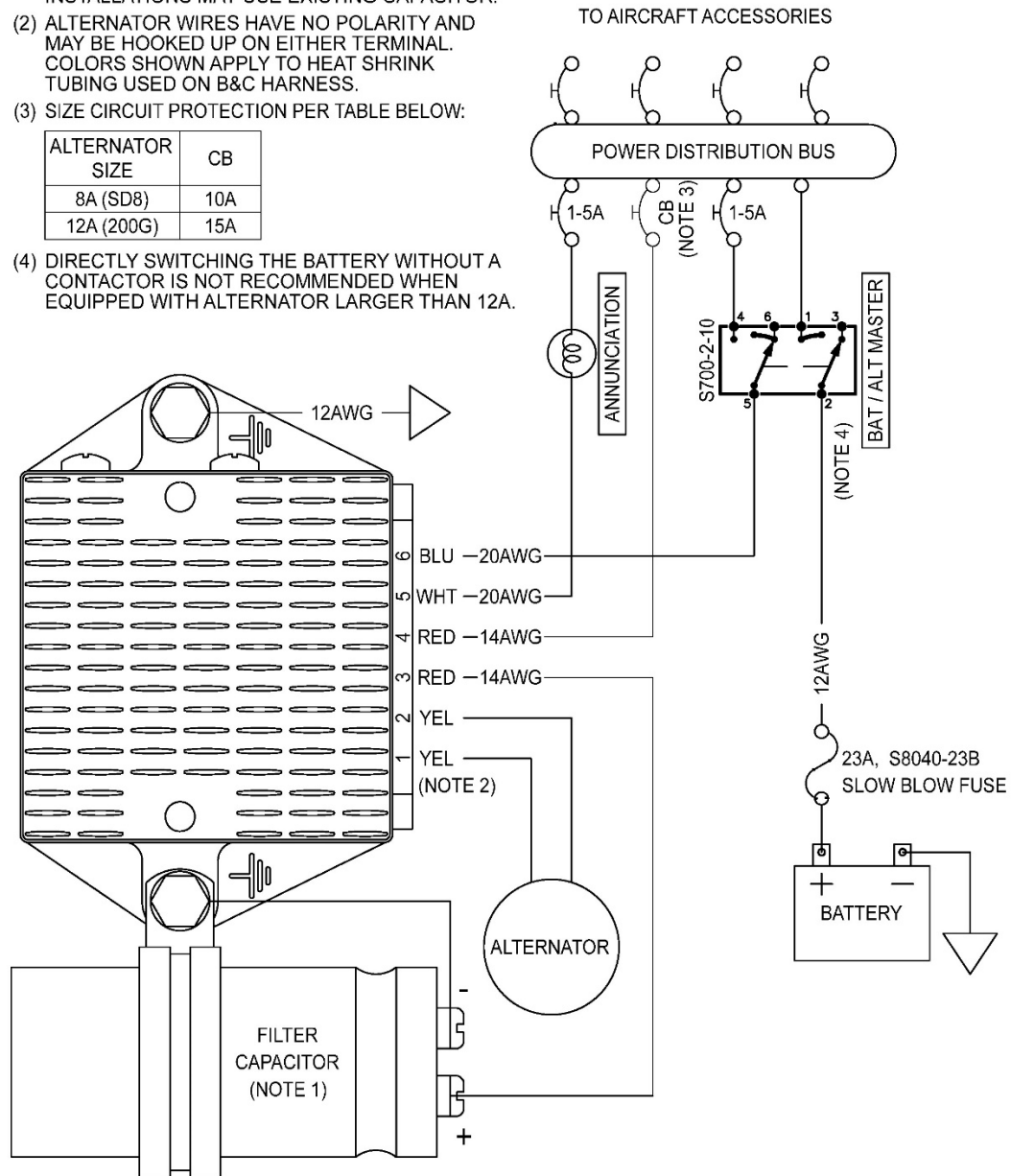



123 East 4th Street, Newton KS 67114
Telephone (316) 283-8000 · Fax (316) 283-7400 · BandC.com

**Instructions for Continued Airworthiness
for
B&C Specialty Products AVC1 / XB101-2 Voltage Controller**

The B&C AVC1 voltage controller requires no recurrent maintenance and has an indefinite service life. At each Annual or 100-hour inspection required by the FAA, check the controller externally for security of mounting, tightness of wire terminals, and chafing or breakage of wiring. Perform an operational check to determine that the regulator maintains the aircraft electrical bus at its approximate set point as loads are added and removed.

Failure due to broken wires or damaged connectors may be corrected in the field using repair procedures complying with the latest revision of AC43.13-xx. Use only phosphor-bronze wire terminals finished with insulating heatshrink for repairs to the AVC1 interface harnesses.

The set-point for regulated voltage may be changed in the field by adjusting the 12-turn voltage-set potentiometer, if required. This potentiometer is located under the machine screw cap labeled “VOLT ADJUST” on the side of the AVC1 enclosure. A small flat-blade screwdriver may be used for the adjustment; clockwise rotation increases the set voltage at a rate of 0.2V per turn.

Adjustment of the Low-Voltage (LV) warning output may be accomplished by use of field-accessible DIP switches, if required. The DIP switches are located under the machine screw cap labeled “CONFIG” on the side of the AVC1 enclosure; switch 1 is on the left and switch 2 is on the right. Configuration options are: LV Output DISABLE = SW1 DOWN, SW2 DOWN; LV Output 25.4V = SW1 DOWN, SW2 UP; LV Output 26.0V = SW1 UP, SW2 DOWN; and LV Output 27.0V = SW1 UP, SW2 UP.

The Charging-System Fault (CSF) warning output is fixed and non-adjustable.

All other repairs are by replacement only.

**INSTALLATION OF THIS UNIT ON A TYPE-CERTIFICATED AIRCRAFT
MUST BE ACCOMPANIED BY AN STC OR BY A ONE-TIME FIELD APPROVAL**